

MODELL
GBA

Strom in oder aus Arbeitsanschluss A oder B
EINSCHRAUBBOHRUNG: T-13A

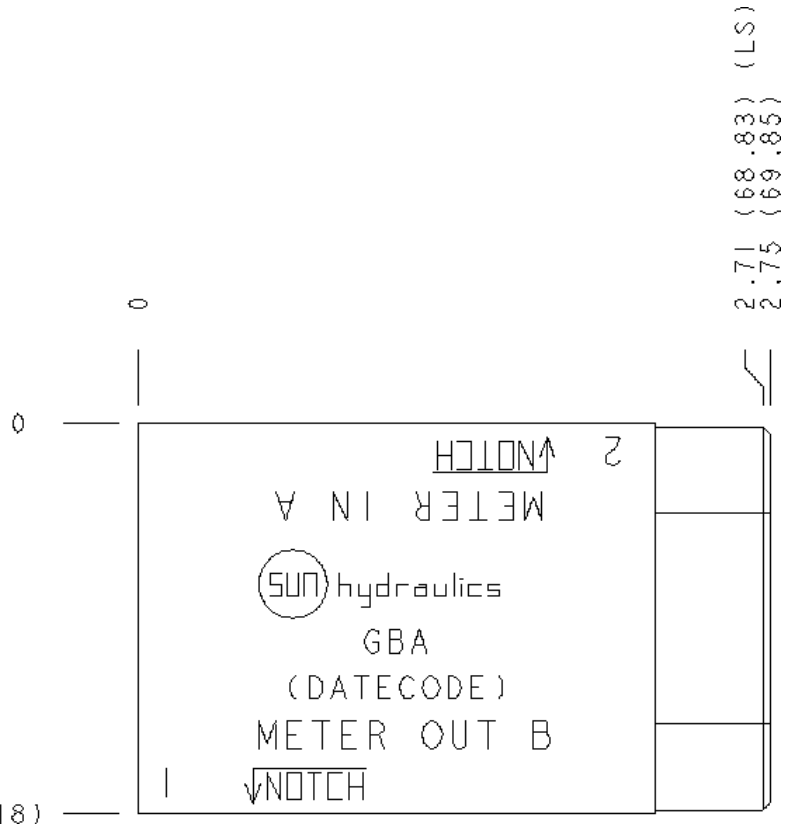
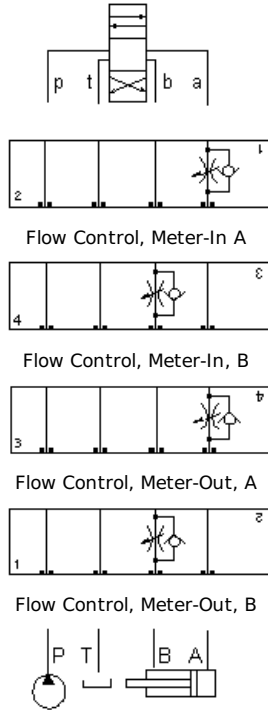

KONFIGURATION ÄNDERN

(none) Modifier 6061-T651 Aluminum, Buna-N

KOMPONENTEN

Part	Beschreibung	Anzahl
500-001-012	O-Ring	4
700-002	Seal Plate	1
811-001-006	Pin	1

TECHNISCHE DATEN

Gehäusetyp	Sandwich
Lochbild	ISO 03
Gehäuseeigenschaften	Strom in oder aus Arbeitsanschluss A oder B
Verkettungshöhe	44,5 mm
Einschraubbohrung	T-13A
Open Cavities	1

BEMERKUNGEN

Important: Carefully consider the maximum system pressure. The pressure rating of the manifold is dependent on the manifold material, with the port type/size a secondary consideration. Manifolds constructed of aluminum are not rated for pressures higher than 3000 psi (210 bar), regardless of the port type/size specified.

SYMBOLS

Flow Control, Meter-In A



Flow Control, Meter-In, B

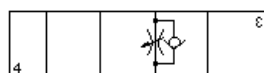

Flow Control, Meter-Out, A



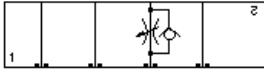

CONFIGURATION OPTIONS

MODIFIER

Standard Options	/S	6061-T651 Aluminum, Buna-N
	/V	65-45-12 Ductile Iron, Buna-N, Blackened
	/Y	6061-T651 Aluminum, Viton
		65-45-12 Ductile Iron, Viton, Blackened

MANIFOLD FACES

FACE GRID

1	2	3	4
5	6	7	8
9	10	11	12

Face 2

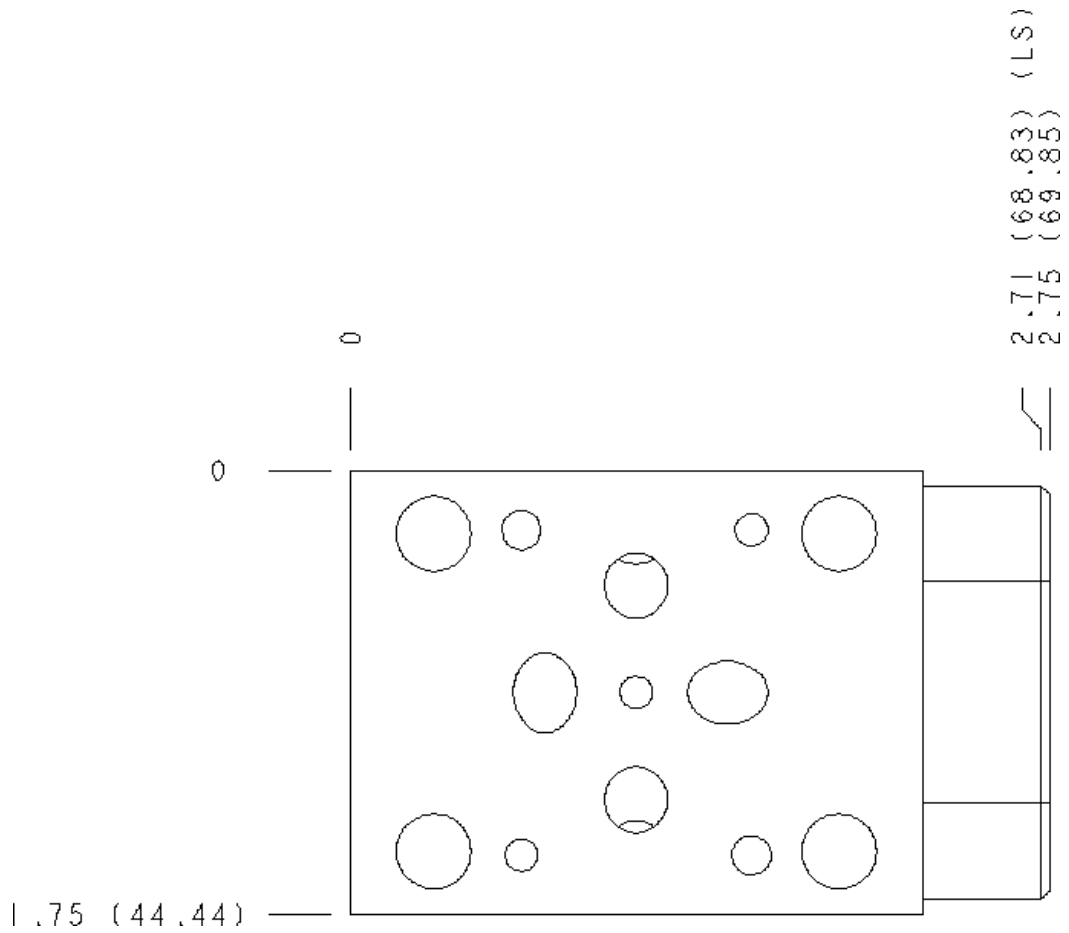

Face 5

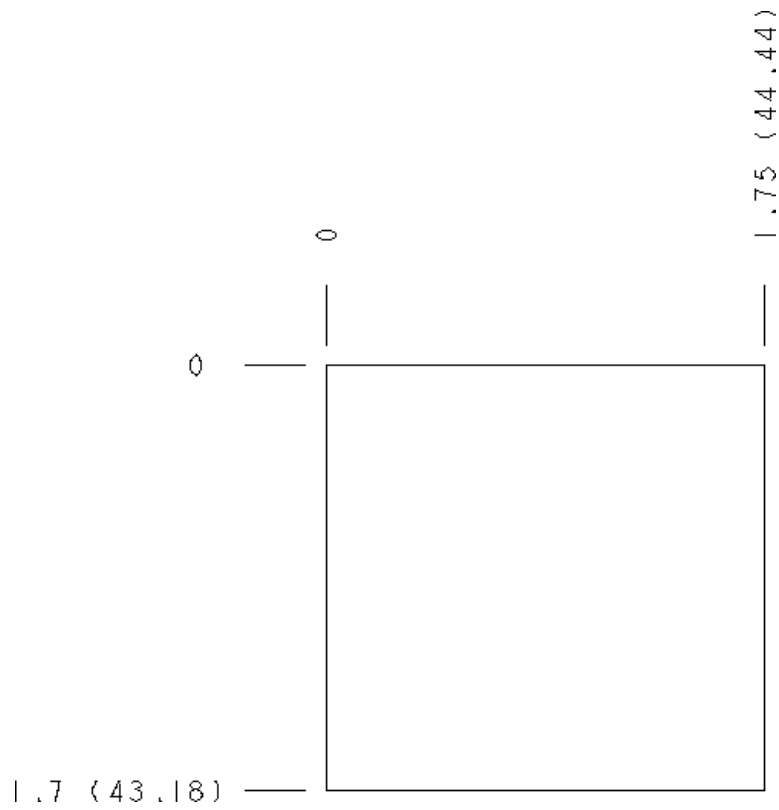

Face 6

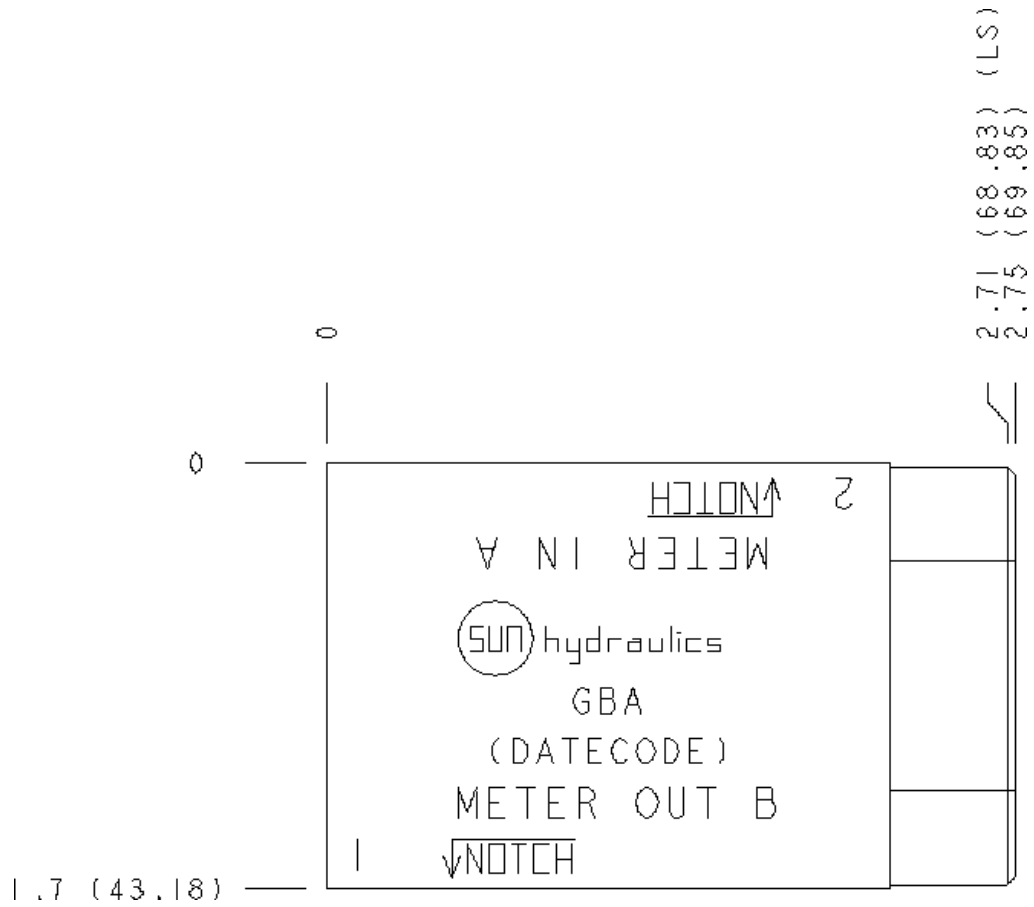

Face 7

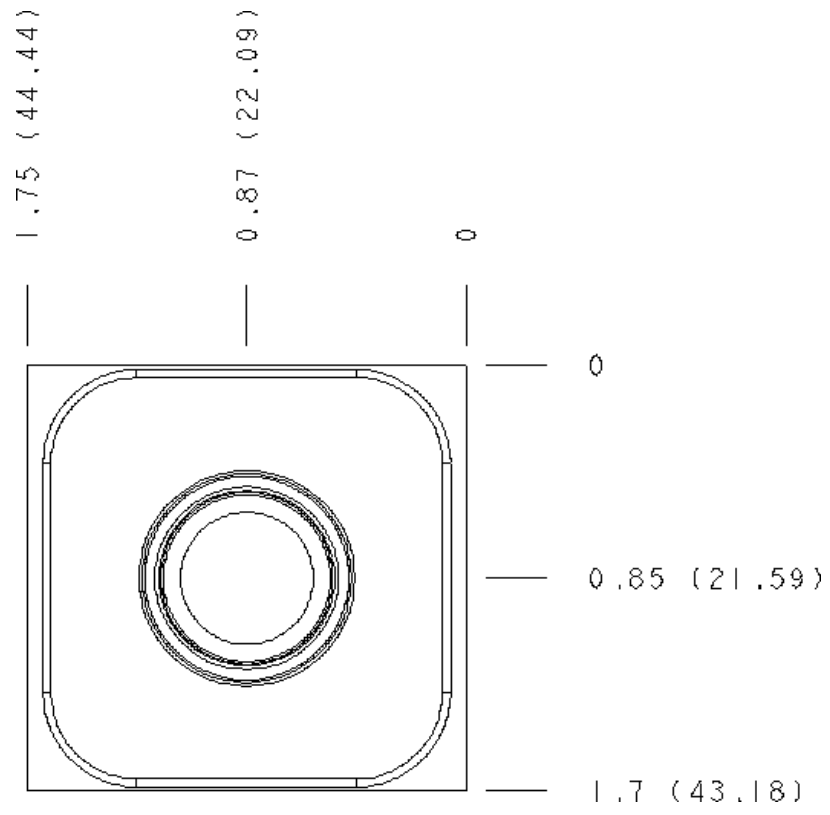

Face 8

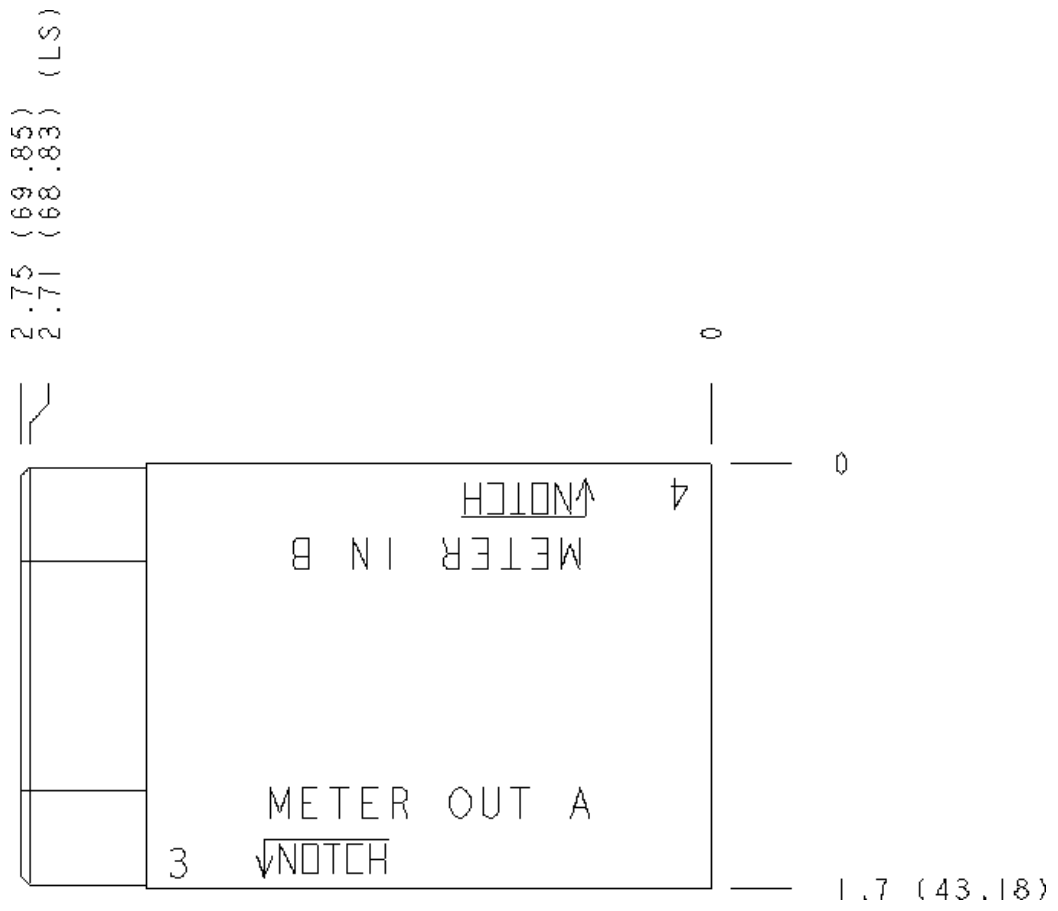

Face 10

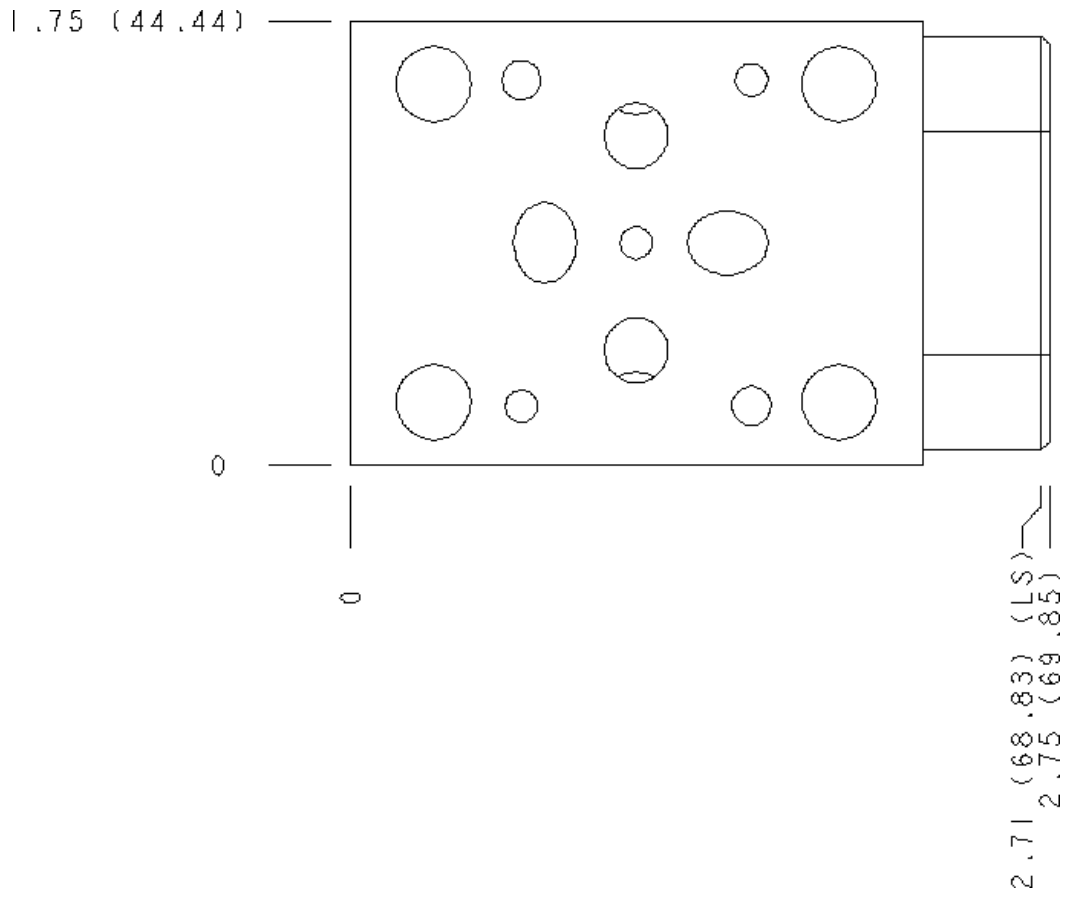

Copyright © 2002-2014 Sun Hydraulics Corporation. All rights reserved.